

1C/2C-TYPE COIN TELEPHONE SET DETAILED DESCRIPTION

	PAGE		PAGE
1. GENERAL	5	G. Incoming Call	23
2. FUNCTIONS	6	COIN FIRST SERVICE	23
A. Coin Chute	6	A. Originating A Call	23
Nickel Operation	6	B. Restoring Set to Standby	23
Dime Operation	6	C. Call Abandoned	24
Quarter Operation	8	D. Nickel Local Overtime	24
Coin Release	9	E. Coin Disposal Test	25
B. Totalizer	9	F. Toll Call	25
C. DTF and CF Mode	9	G. Incoming Call	26
D. Coin Chassis	12	4. SEQUENCE CHARTS	26
E. Coin Dial Unit	12		
F. Coin Relay and Hopper Assembly	14		
G. Other Component Circuits	15		
3. THEORY OF OPERATION	18		
DIAL-TONE-FIRST SERVICE	18		
A. Originating A Call	18		
B. Restoring Set to Standby	21		
C. Call Abandoned	21		
D. Nickel Local Overtime	21		
E. Coin Disposal Test	22		
F. Toll Call	22		
		1. GENERAL	
		1.01 The 1C/2C coin telephone set is capable of providing coin service in either coin-first (CF) or dial-tone-first (DTF) systems. The set can be converted in the field from one mode of operation to the other.	
		 <i>Components in this set are designed to operate reliably in a temperature range between -30 degrees and +140 degrees Fahrenheit.</i>	
		1.02 The 1C/2C set is available with rotary or TOUCH-TONE® dial.	
		1.03 Codes for the 1C- and 2C-type sets are described in Table A.	

TABLE A
CODE SIGNIFICANCE

CODE	FIRST NO.	LETTER	SECOND NO.
1C1	Box Type	CF or DTF Mode (Convertible)	Rotary Dial
1C2			TOUCH-TONE Dial
2C1	Panel Type		Rotary Dial
2C2			TOUCH-TONE Dial

1.04 Abbreviations used in this section are as follows:

- ACTS—Automated Coin Toll Service
- CF—Coin-First
- DTF—Dial-Tone-First
- TT—TOUCH-TONE Dial
- DP—Dial Pulse
- DON—Dial Off Normal
- EM—Electromechanical
- EIB—Expanded-in-Band
- CR—Coin Relay
- RE—Reset Electromagnet
- CO—Central Office
- TSPS—Traffic Service Position System
- SH—Switchhook
- SCR—Silicon Controlled Rectifier (voltage and current controlled electronic switching).

2. FUNCTIONS

A. Coin Chute (Fig. 1)

Nickel Operation

2.01 *Nickel Operation—Valid Coin Accepted (Fig. 2).*

- (1) Nickel is deposited in coin entrance and passes magnetic trap.
- (2) Nickel continues and is checked for size and weight as the nickel separator rotates.
- (3) Nickel is channeled into the nickel magnet area.
- (4) The nickel magnet sets up an eddy current effect which slows its movement down the chute.
- (5) The nickel continues on, falls toward the rear of the chute, strikes the nickel anvil, bounces over the nickel divider, and is accepted.

2.02 *Nickel Operation—Coin Rejected (Fig. 2).*

- (1) Light weight magnetic slugs or coins will be stopped by the magnetic trap.
- (2) If the size or weight is incorrect, it will be stopped at various locations in the chute and must be retrieved by operation of the coin release mechanism.
- (3) If the eddy current characteristics are incorrect, the bounce on the nickel anvil will cause the coin to be rejected.

Dime Operation

2.03 *Dime Operation—Valid Coin Accepted (Fig. 3).*

- (1) Dime is deposited in coin entrance and passes magnetic trap.
- (2) Dime continues and is checked for size and weight as the dime separator rotates.
- (3) Dime is channeled into the dime magnet area.
- (4) The dime magnet sets up eddy current effect which slows its movement down the chute.
- (5) Dime drops through the dime divider and is accepted.

2.04 *Dime Operation—Coin Rejected (Fig. 3).*

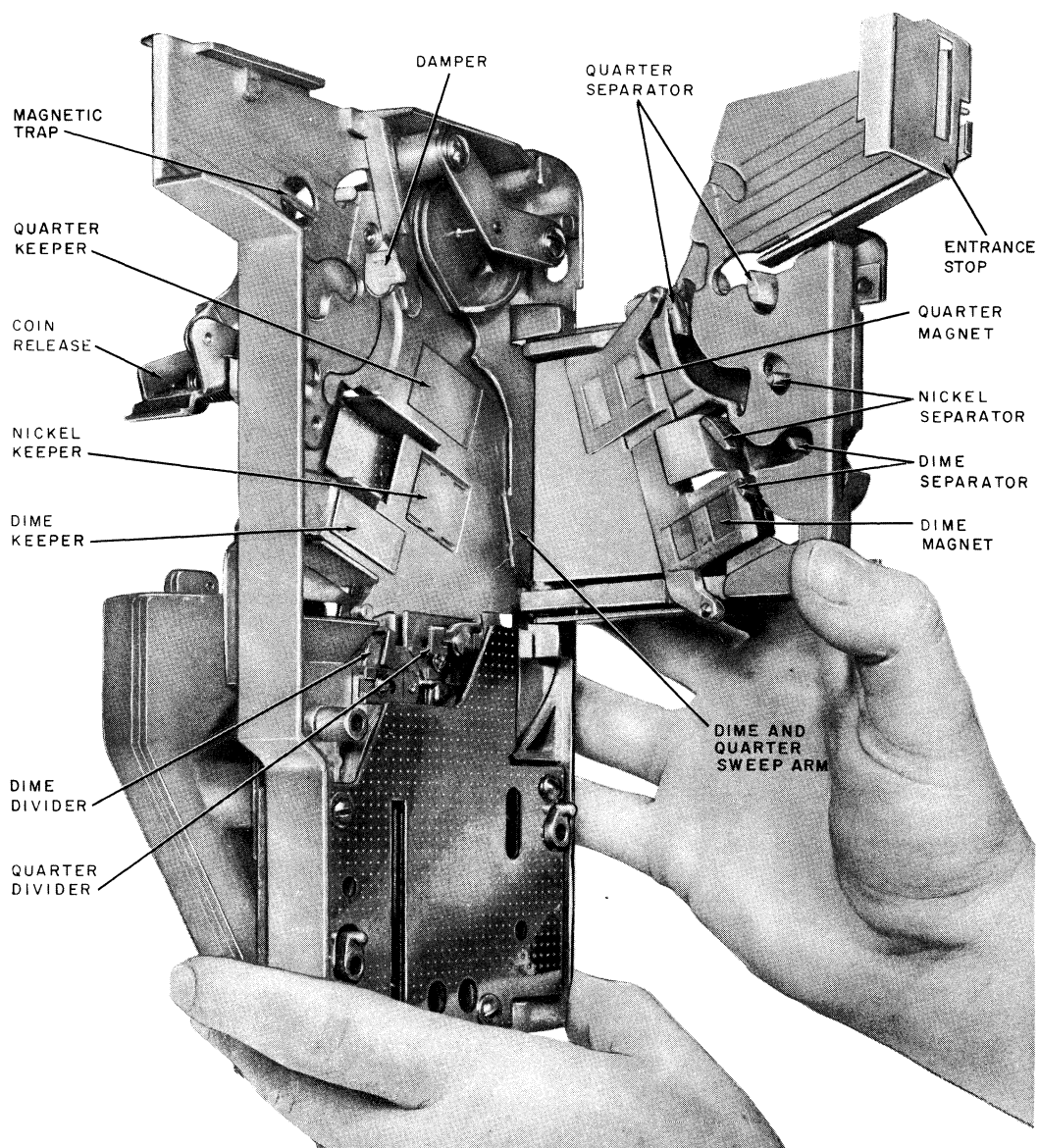

Fig. 1—Typical Coin Chute

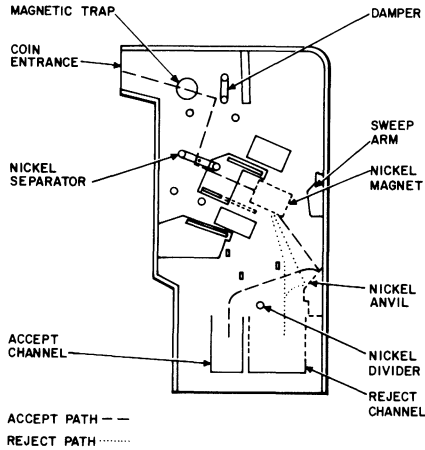

Fig. 2—Nickel Path in a Typical Coin Chute

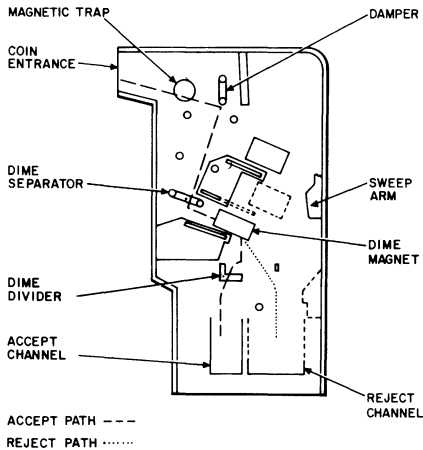

Fig. 3—Dime Path in a Typical Coin Chute

- (1) Light weight magnetic slugs or coins will be stopped by the magnetic trap.
- (2) If the size or weight is incorrect, such as a penny used in coin phone tests, it will be stopped at various locations in the chute and must be retrieved by operation of the coin release mechanism.

- (3) If the eddy current characteristics are incorrect the dime magnet, with the aid of the divider, will reject the coin.

Quarter Operation

2.05 Quarter Operation—Valid Coin Accepted (Fig. 4).

- (1) Quarter is deposited in coin entrance and passes magnetic trap.
- (2) Quarter continues and is checked for size and weight as the quarter separator rotates.
- (3) Quarter is channeled into the quarter magnet area.
- (4) The quarter magnet sets up an eddy current effect which slows its movement down the chute.
- (5) Quarter strikes the right side (as viewed in Fig. 4) of quarter divider and is accepted.

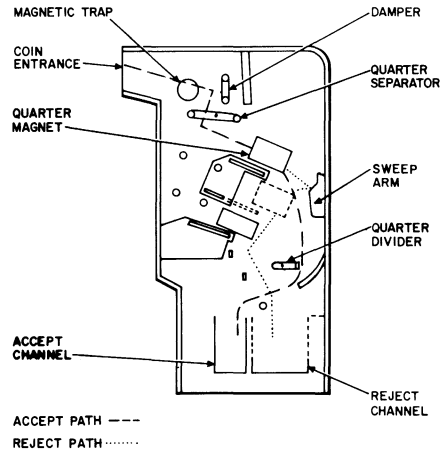

Fig. 4—Quarter Path in a Typical Coin Chute

2.06 Quarter Operation—Coin Rejected (Fig. 4).

- (1) Light weight magnetic slugs or coins will be stopped by the magnetic trap.

- (2) If the size or weight is incorrect, it will be stopped at various locations in the chute and must be retrieved by operation of the coin release mechanism.
- (3) If the eddy current characteristics are incorrect, the bounce on the sweep arm will cause the coin to be rejected.

Coin Release

2.07 Coin Release Mechanism Operation.

- (1) The magnetic trap is withdrawn to release trapped magnetic material.
- (2) The chute opens to release coins stopped at various locations.
- (3) Sweep arms clear material from the coin magnet areas and direct stopped material to the reject channels.

B. Totalizer (Fig. 5)

2.08 The totalizer is an electromechanical device that has the ability to total initial rate deposits, prepare the set for calling, and signal coin denominations to the operator. Minimum loop current required to operate the totalizer reliably is 23 milliamps.

2.09 Accepted coins fall through the chute and strike totalizer arms, which project into the chute. Nickels and dimes strike the lower arm while quarters strike the upper arm. Arm deflection causes a ratchet wheel to rotate and operate a cam. Each cog on the ratchet wheel represents a 5-cent increment. The cam shaft is rotated 10 degrees by each nickel deposited, 20 degrees by each dime, and 50 degrees by each quarter.

C. DTF and CF Mode

2.10 The totalizer contains several components described as follows:

(a) *DTF Mode*

(1) *T1 (Initial Rate) Contacts.*

- (a) Its normally open contacts, when operated, provide a path for the initial rate ground test.

- (b) Its normally closed contacts allow totalizer to total deposits up to initial rate before reading out.

(2) *T2 (Totalizer Off Normal) Contacts.*

- (a) Operate (transfer) when any coin is deposited.
- (b) The normally closed contacts short the totalizer during talking.
- (c) The normally open contacts, when operated, provide a path through the speech network to allow totalizer to restore to normal when going on-hook.

(3) *S (Stepping) Relay and its S1 Contacts.*

- (a) The operating and releasing action of the S relay steps the totalizer back 10 degrees each time it operates.
- (b) This action continues until T2 goes back to normal thus shorting the totalizer.
- (c) Operation of S1 transfer contacts alternately applies power to the S relay and coin tone oscillator, thus stepping totalizer back to home position and generating coin signals.

(4) *C (Coin Arm Off-Normal) Contacts.*

- (a) On all coin deposits, the C contacts transfer to prevent the totalizer from stepping back while the coin arm is held down by a coin.
- (b) The normally closed C contacts, when opened, remove the current path from the S relay while the normally open contacts, when closed, connect a click suppression circuit.

(5) *CS (Coin Signal Speed Changing) Contacts.*

- (a) The CS contacts operate only on quarter deposits.

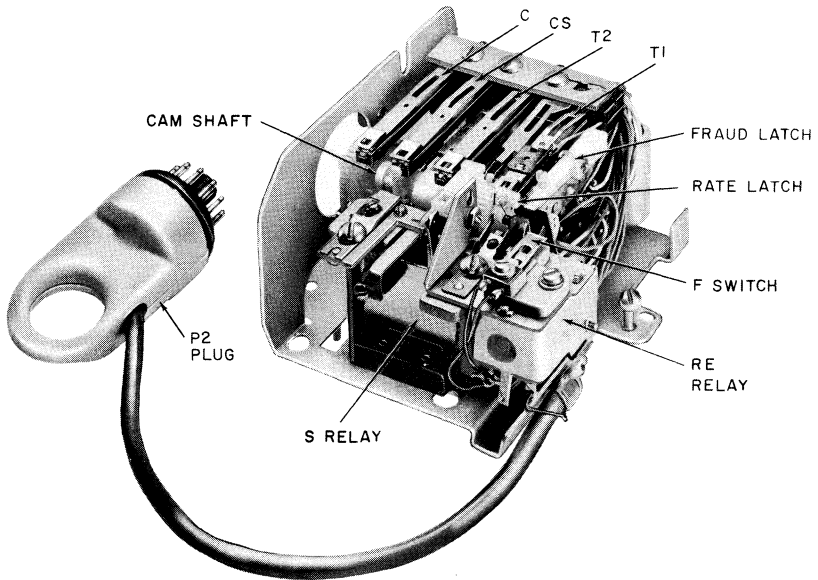

VIEW A

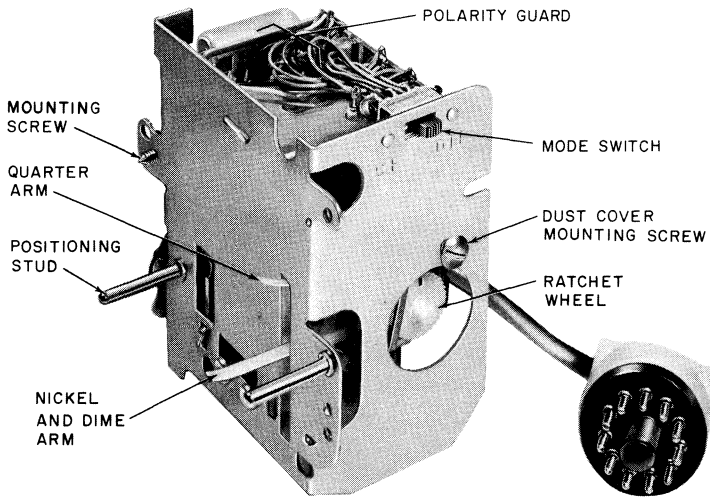

VIEW B

Fig. 5—1A Totalizer

(b) The normally closed CS contacts open to allow more voltage across the S relay, thus providing a faster readout.

(c) The normally open CS contacts bypass the normally closed C contacts to allow the S relay coil to energize thereby allowing early totalizer response before the quarter arm returns to normal.

(6) **RE (Reset Electromagnet).**

(a) The primary function of the RE relay is to reset the T1 contacts to normal on coin collect or refund pulses.

(b) When the initial rate is registered in the totalizer, the T1 contacts operate and the spring loaded rate latch engages holding T1 in its operated position.

(c) When the RE armature operates, it disengages the rate latch and T1 restores to normal.

(d) A second function of the RE relay is to control the F (fraud) switch.

(7) **Antifraud Provisions (F Switch Contacts and FRAUD Latch).**

(a) Operation of the RE opens the F switch.

(b) The fraud latch drops down each time the totalizer goes off home position.

(c) If the RE operates while the fraud latch is down (totalizer off home position) the F switch will open and be held open by the fraud latch until the totalizer steps back to home position, thus preventing the possibility of fraudulently satisfying the initial rate ground check. This prevents calls from being made for less than initial rate.

(8) **Internal Polarity Guard:** The polarity guard around the totalizer circuit allows it to operate on positive or negative battery.

(b) **CF Mode**

(1) **T1 (Initial Rate) Contacts.**

(a) The normally open contacts operate to close the ring lead and cause CO ground start when initial rate is deposited.

(b) The normally closed contacts open to remove dial short when initial rate is deposited.

(2) **T2 (Totalizer Off-Normal) Contacts.**

(a) Operate (transfer) when any coin is deposited.

(b) The normally closed contacts short the totalizer during talking.

(c) The normally open contacts when operated, provide a path through the speech network to allow totalizer to restore to normal when going on-hook.

(3) **S (Stepping) Relay and Its S1 Contacts.**

(a) The operating and releasing action of the S relay steps the totalizer back 10 degrees each time it operates.

(b) This action continues until T2 goes back to normal thus shorting the totalizer.

(c) Operation of S1 transfer contacts alternately applies power to the S relay and coin tone oscillator, thus stepping totalizer back to home position and generating coin signals.

(4) **C (Coin Arm Off-Normal) Contacts.**

(a) On all coin deposits, the C contacts transfer to prevent the totalizer from stepping back while the coin arm is held down by a coin.

(b) The normally closed C contacts, when opened, remove the current path from the S relay; while the normally open contacts, when closed, connect a click suppression circuit.

(5) **CS (Coin Signal Speed Changing) Contacts.**

- (a) The CS contacts operate only on quarter deposits.
- (b) The normally closed CS contacts open to allow more voltage across the S relay, thus providing a faster readout.
- (c) The normally open CS contacts bypass the normally closed C contacts to allow the S relay coil to energize, thereby allowing early totalizer response before the quarter arm returns to normal.

(6) **RE (Reset Electromagnet).**

- (a) The primary function of the RE relay is to reset the T1 contacts to normal on coin collect or refund pulses.
- (b) When the initial rate is registered in the totalizer, the T1 contacts operate and the spring loaded rate latch engages and holds T1 in its operated position.
- (c) When the RE armature operates, it disengages the rate latch and T1 restores to normal.
- (d) A second function of the RE relay is to control the F (fraud) switch.

(7) **Antifraud Provision (F Switch Contacts and Fraud Latch).**

- (a) The F switch provides no essential function in the CF mode.
- (b) The fraud latch operates when totalizer is off normal and RE is operated, thus preventing fraudulent ground start and the station is put out of service.

(8) **Polarity Guard:** The polarity guard around the totalizer circuit allows it to operate on positive or negative battery.

2.11 Output characteristics of the totalizer are as follows:

(1) **Tone Pulsing:**

- (a) Fast readout (quarter only)—5 beep tones
 - (1) Pulsing rate—12-17 PPS.

(b) Slow readout (nickel and dime only)

- (1) Nickel—1 beep tone
- (2) Dime—2 beep tone
- (3) Pulsing rate—5-8.5 PPS.

D. Coin Chassis (Fig. 6)

2.12 The coin chassis is a framework for mounting electrical components as follows:

- (1) **B Relay**—The B relay contacts close during totalizer readout and place a capacitor across the speech circuit to prevent the customer from hearing coin signals.
- (2) **Coin Signal Oscillator**—Generates a dual frequency signal, controlled by totalizer readout indicating to the ACTS receiver or operator what value of coin has been deposited.
- (3) **A Relay**—Provides ground lifting in DTF mode and controls totalizer readout in CF mode.

E. Coin Dial Unit (Fig. 7)

2.13 The dial and housing assembly contains the switchhook contacts and rotary or TOUCH-TONE dial. The switchhook contacts are operated as the handset is lifted. Contacts SH1, SH2, and SH4 perform the same functions in both CF and DTF modes. SH3 differs as described in (3).

- (1) **SH1**—When operated, SH1 connects the receiver in the speech circuit. The normally closed contacts (when handset is on hook) provide for insufficient deposit refund.
- (2) **SH2**—A mercury switch, connected in parallel with SH4, which prevents switchhook dialing in the CF mode.
- (3) **SH3**—In the DTF mode, its normally closed contacts, when operated, allow totalizer to total deposits up to initial rate before reading out. In CF mode (handset on hook), SH3 normally closed provides a short path to permit insufficient deposit refund.
- (4) **SH4**—Closes ring lead when operated.

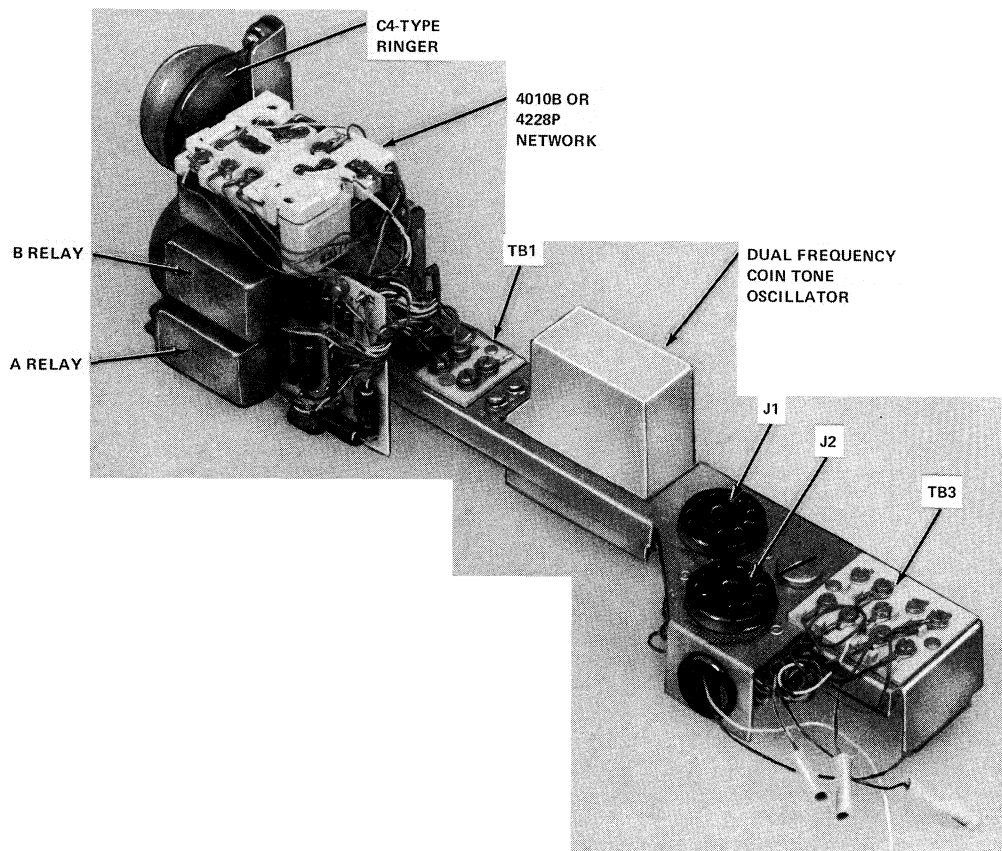

Fig. 6—31A Coin Chassis

(5) **Rotary dial contacts.**

- (a) DP—Dial pulsing contacts
- (b) DON 1—Operates when dial is off normal. Shorts receiver to prevent acoustic shock.
- (c) DON 2—Used in DTF mode only. Prevents totalizer readout during dialing.

(6) **TOUCH-TONE dial common switch.**

Note: This procedure and Fig. 10 refer to TOUCH-TONE dials.

- (a) The break contact places a resistor in series with the receiver to enable customer to hear low level TOUCH-TONE signals.
- (b) The transfer contacts disconnect the transmitter and connect the dial oscillator.
- (c) The make contact is used in DTF mode only. It prevents totalizer readout during dialing.

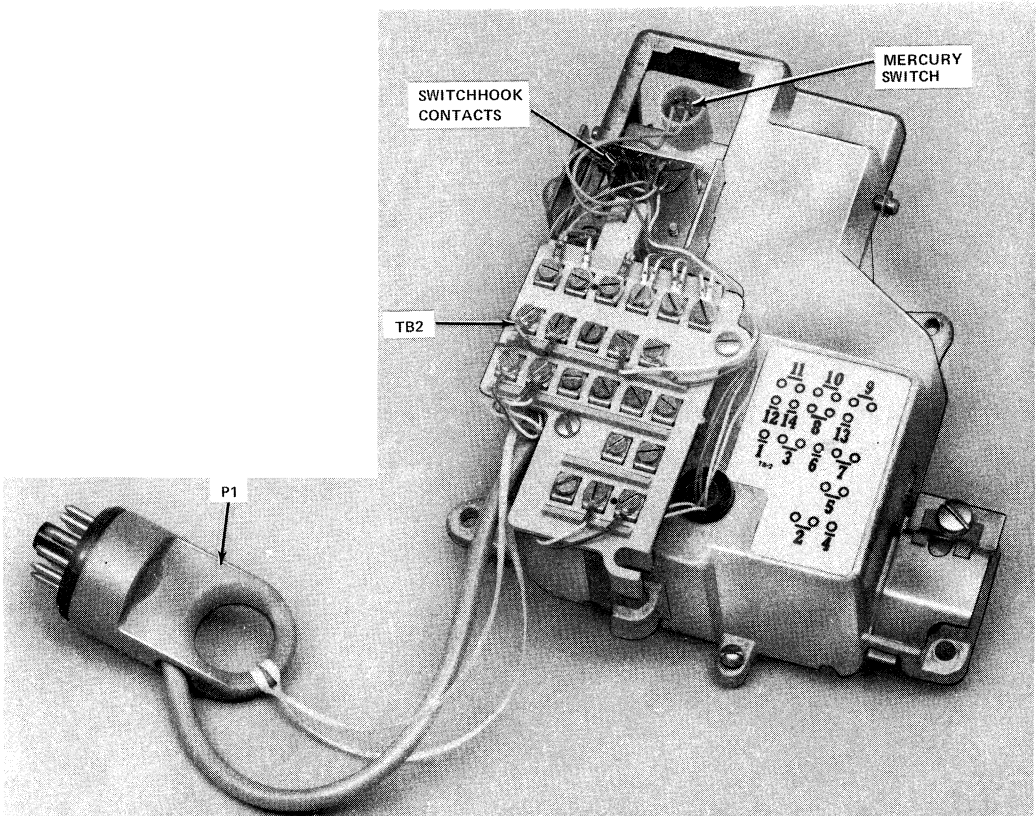

Fig. 7—Typical Coin Dial Unit

F. Coin Relay and Hopper Assembly (Fig. 8)

2.14 The coin relay and hopper assembly is an electromechanical unit which controls the coin collect or coin refund function.

2.15 The resistance of the 1A coin relay winding is approximately 1020 ohms at 70 degrees Fahrenheit and is effected by temperature changes.

2.16 Operating Values of Coin Relays are:

- Minimum operate current—41 milliamps
- Nonoperate current—30 milliamps

- Operating time—450 ±50 milliseconds (+20° to 100°F)

2.17 Hopper trigger (HT) contacts are closed by the first coin deposited. All coins deposited are temporarily stored in the hopper, on the coin trap, until dumped when the coin relay operates.

2.18 The selector card is polarized to move to the right or left, depending on the polarity of the central office voltage applied. This mechanically operates the cam which in turn operates the coin vane in hopper to collect or refund coins.

2.19 Upon release of coin relay operating cycle, the HT and coin trap restore to normal.

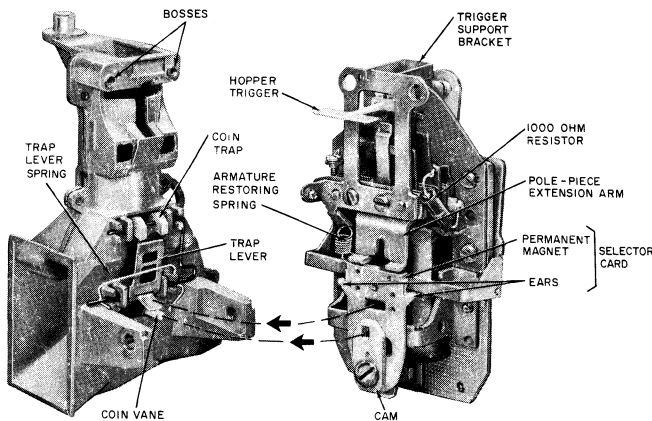

Fig. 8—1AA Coin Relay

G. Other Component Circuits (Fig. 9 through 12)

2.20 Speech Circuit: The speech circuit is a standard telephone speech network. The tip and ring connections are reversed with respect to the usual 500 set connections to guarantee a path from tip to ground that does not go through the transmitter. The ground connection is at the ac balance point of the network to reduce noise due to unbalance when the ground is connected.

2.21 Ground Lifting Circuit (Used in DTF only) (Fig. 9 and 10).

(a) The ground lifting circuit is composed of the A relay, a polarity guard, and associated varistors, resistors, and capacitors. When loop current is flowing in the ring lead, the A relay operates to remove the ground connection at the station. Removal of ground at the station reduces noise unbalance.

(b) Capacitors outside the polarity guard lower the ac impedance and prevent transients induced by collect or refund pulses.

2.22 Coin Return Network (Used in DTF only) (Fig. 9 and 10).

(a) The coin return network is composed of an SCR, a zener diode, and associated resistors, thermistor, and diode. The principle function of this circuit is to allow refund to occur if the T1 contact in the ground lead is open.

(b) When the high negative voltage coin pulse is applied to the tip lead, the SCR switches and permits current to flow allowing coin relay and RE to operate.

(c) When -48 volts is applied to the tip lead, during the initial rate ground test, current flows if T1 is operated. The -48 volts is insufficient to switch the SCR.

(d) When the coin present test is made with +48 volts on the tip lead, the diode bypasses the network to allow successful completion of the test.

(e) The zener diode controls the firing level (67 volts) of the SCR.

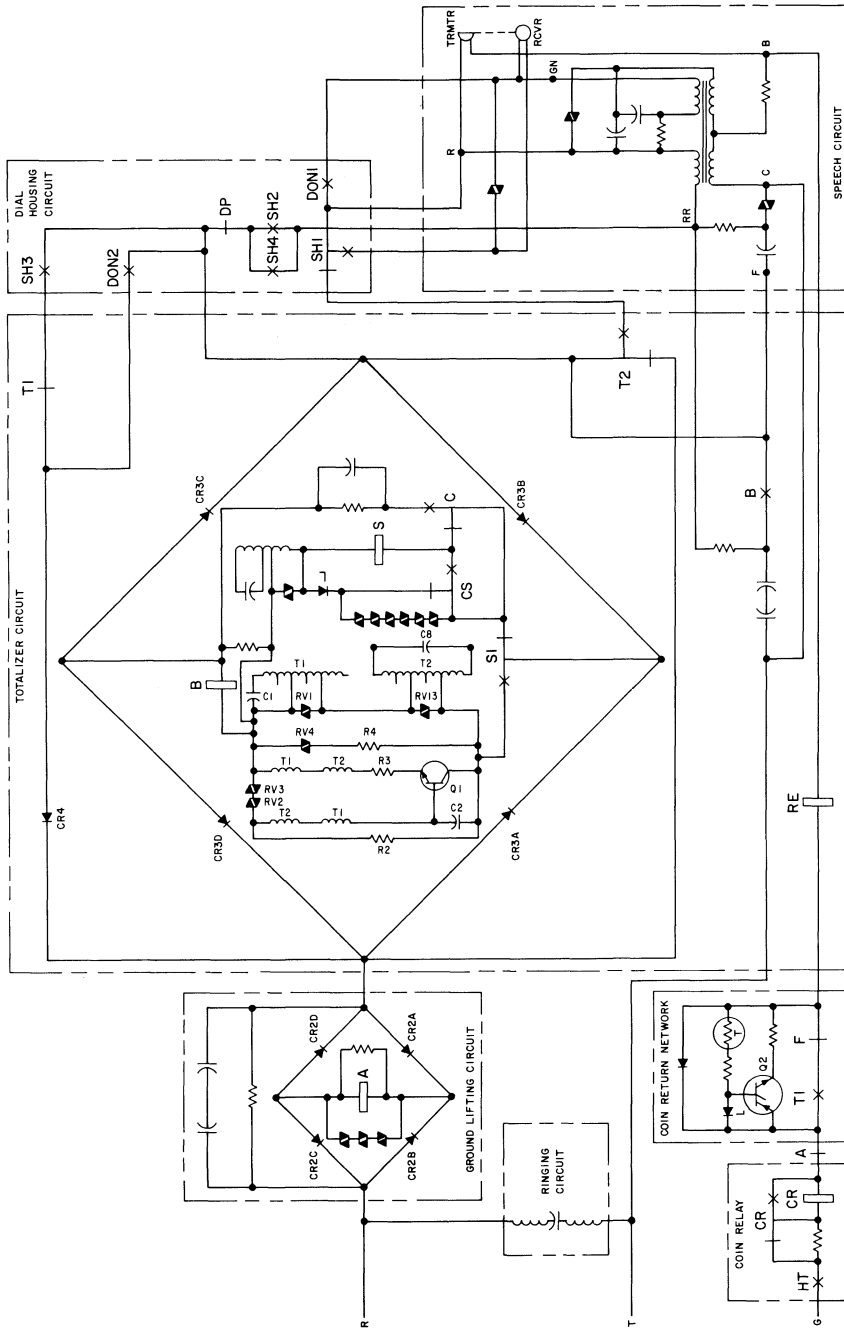

Fig. 9—1C1/2C1 Coin Telephone Set—Schematic (DTF Mode)

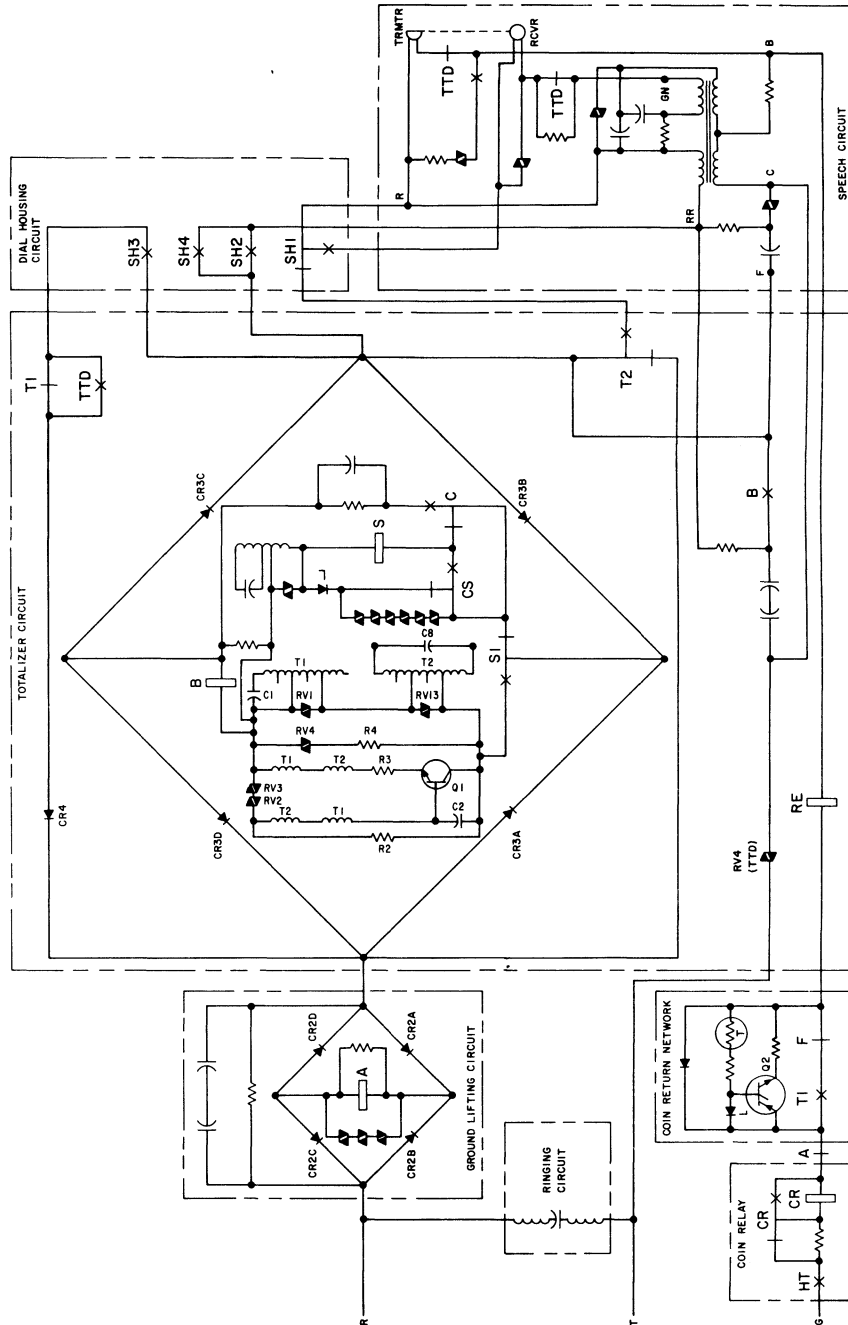

Fig. 10—1C2/2C2 Coin Telephone Set—Schematic (DTF Mode)

- (f) Resistors and thermistor are used to compensate for temperature variation.

2.23 Tip Relay Circuit (Used in CF only) (Fig. 11 and 12).

- (a) The A relay circuit is placed in the tip lead in the CF mode.
- (b) After initial rate deposit, and tip is grounded at the CO, the A relay operates and allows the totalizer to read out after each subsequent coin deposit.

3. THEORY OF OPERATION

DIAL-TONE-FIRST SERVICE (Fig. 9 and 10)

A. Originating A Call

3.01 In DTF service, the central office line equipment is wired for loop start (ring -48 volts; tip grounded).

3.02 When the handset is lifted, switchhook contacts SH3, SH2 and SH4, and SH1 operate in that order and loop current flows from the ring lead to tip. This path is through the A relay winding, the normally closed T2 contact, the operated SH1 and SH4 contacts, through the speech network to tip. Current through this path operates the CO line equipment and the A relay to remove station ground. Dial tone is received.

3.03 Dialing With No Deposit Made.

- (a) If dialing a number with no deposit required, the number can be dialed immediately after dial tone is received and the call will be forwarded.
- (b) If dialing a number which requires a deposit, and no deposit is made, the initial rate ground test is made by the central office. This test occurs at different times (during or after dialing) in various switching systems.
 - During the initial rate ground test, the CO removes -48 volts from ring and connects it to tip, (ring open) thus temporarily releasing the A relay.
 - When no ground is detected (indicating HT or T1 open), the initial rate test has not been satisfied and a recording will instruct

the customer to reinitiate his call with the proper deposit.

3.04 For a partial deposit of initial rate, T2 operates as well as HT and the dial and talking path is maintained. This path is from the ring terminal through the A relay winding, through normally closed T1, operated SH3 contacts, DP contacts (rotary dial only), operated SH2 and SH4 contacts, through the speech network, transmitter, normally closed contacts (TOUCH-TONE dial only), back through the speech network to tip.

3.05 Upon deposit of initial rate, T1 operates, removing the short from totalizer and B relay winding. This allows B relay to operate and current flow to the totalizer and coin signal oscillator. A path now exists from the ring terminal through the A relay winding, B relay winding, S (stepping) relay winding, C and S1 totalizer contacts, through DP contacts (rotary dial only), operated SH2 and SH4 contacts, through the speech network and transmitter, normally closed contacts (TOUCH-TONE dial only), back through the speech network to tip. As S1 transfers and the totalizer reads out, the coin tone oscillator is energized intermittently. The operated B relay bypasses the speech circuit.

3.06 When the totalizer steps back to home, T2 restores, shorting the totalizer and B relay winding. The B relay releases, removing the AC short across the speech network. Even though the totalizer is returned to home position, T1 contact remains operated because it is mechanically latched in its transferred position.

3.07 A dialing and talking path now exists from the ring lead to tip. This path is through the A relay winding, normally closed T2 contacts, normally closed DP contacts (rotary dial only) operated SH2 and SH4, the speech network, transmitter, normally closed contacts (TOUCH-TONE dial only) back through the speech network to tip.

3.08 With a rotary dial, the dial-off-normal contacts short out the receiver during dialing.

3.09 With a TOUCH-TONE dial, the common switch contacts operate during dialing to remove the transmitter from the speech network and also removes the shunt across the level limiting resistor to reduce oscillator sidetone in the receiver.

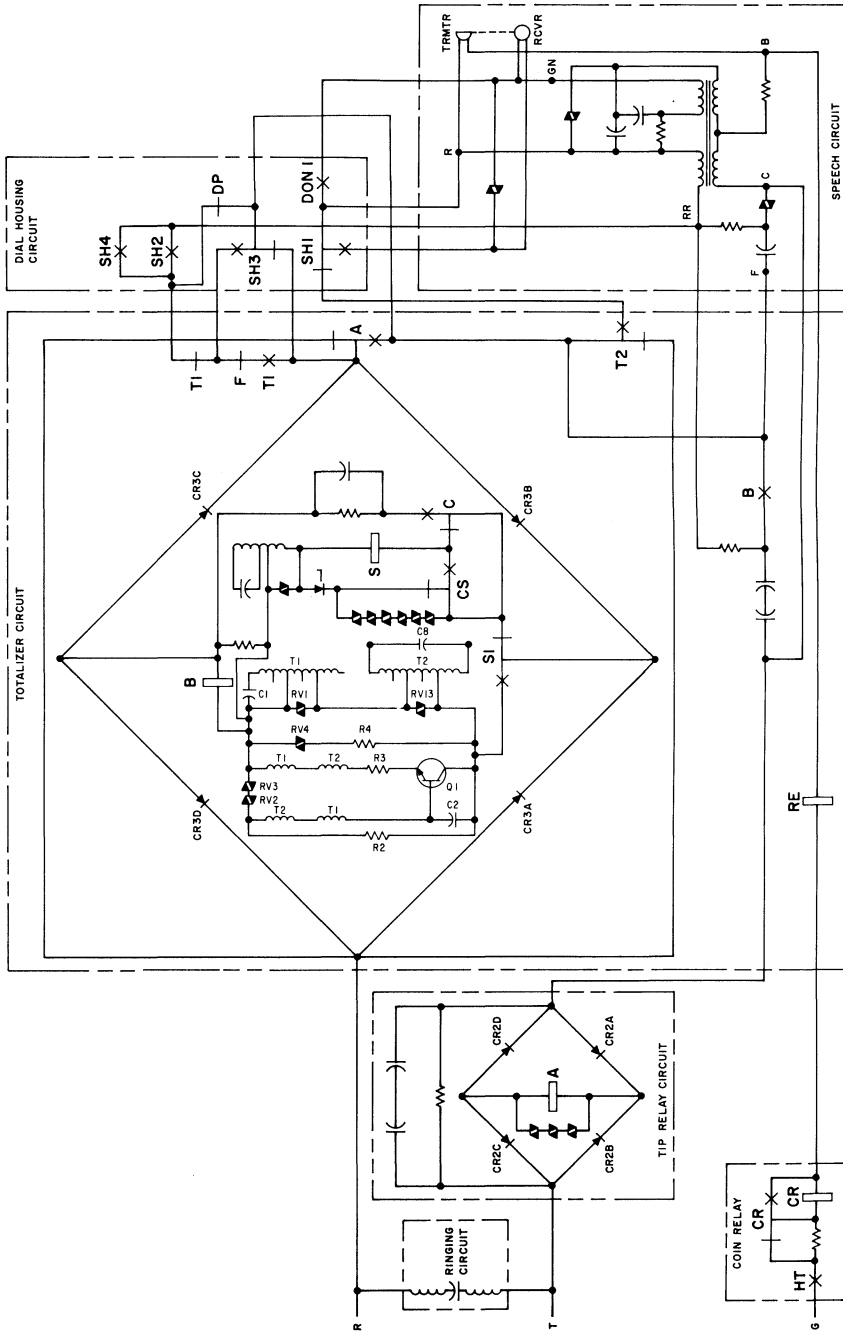

Fig. 11—1C1/2C1 Coin Telephone Set—Schematic (CF Mode)

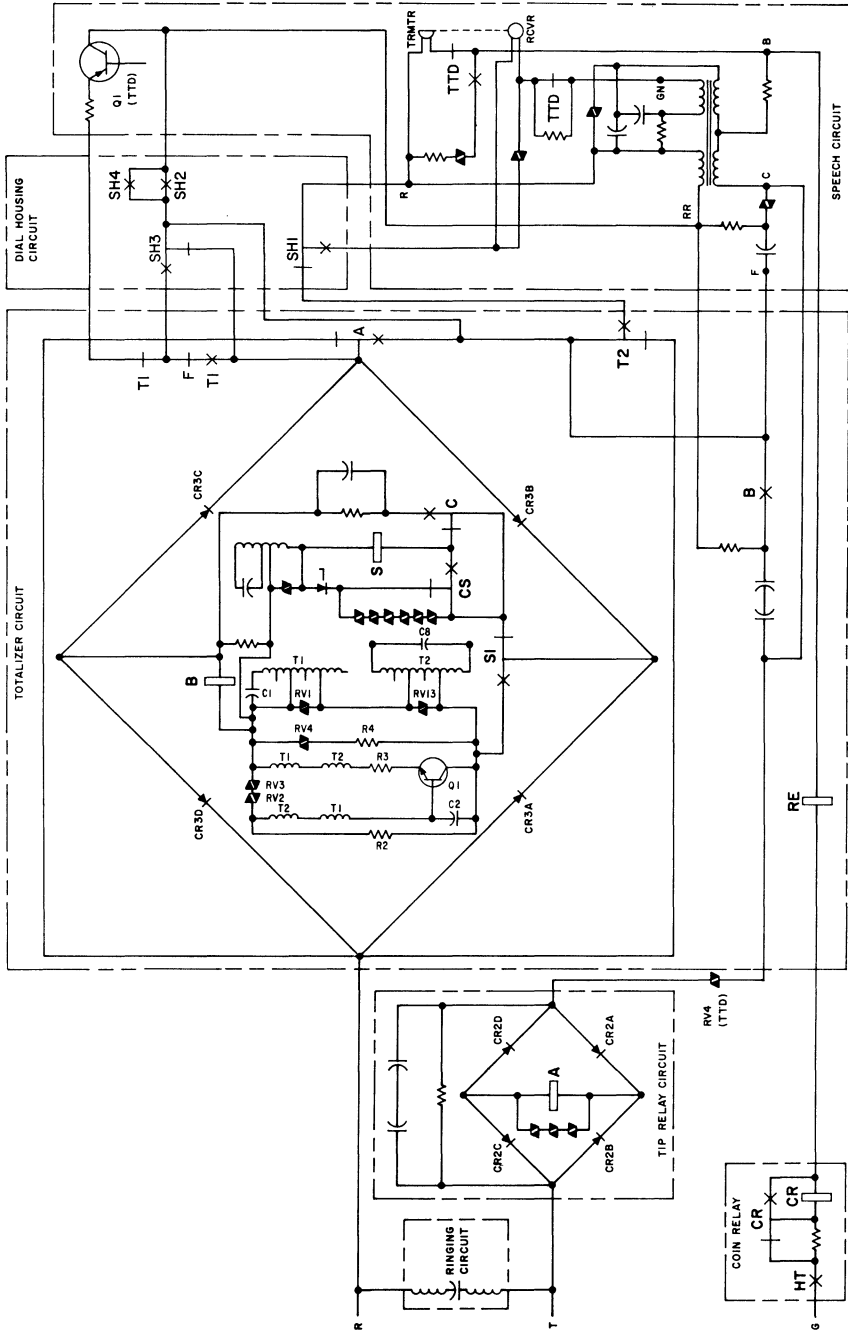

Fig. 12—1C2/2C2 Coin Telephone Set—Schematic (CF Mode)

B. Restoring Set to Standby

3.10 Upon completion of call, customer hangs up handset, SH contacts restore, and the A relay releases. CO removes -48 volts from ring, ground from tip, and a collect (+130 volts) or refund (-130 volts) pulse is applied to tip, operating the coin relay and reset electromagnet (RE).

3.11 Operation of coin relay collects or refunds coin(s), and operation of RE unlatches totalizer contact T1.

3.12 The operated coin relay closes its make contact causing the current to bypass the relay and flow through the resistor which was previously shorted. The short across the relay winding causes the relay to be slow release. The resistor, having approximately the same resistance as the coin relay winding, is placed in the circuit to protect relay contacts in the CO and HT contacts in the set.

3.13 As the coin relay releases, the HT contacts open, placing the coin phone in its idle or standby condition.

Note: See coin disposal test, paragraph 3.22.

C. Call Abandoned**3.14 *Partial Initial Rate Deposited (paragraph 3.04).***

(a) Upon hanging up handset, SH contacts restore. When SH3 restores, the short around the totalizer is removed and current flows through the A relay winding, polarity guard, B relay winding, S relay winding, C and S1 contacts, operated T2, normally closed SH1, and the speech network to tip.

(b) Operation and release action of the S relay causes the totalizer to step back to its home position.

(c) When the totalizer has been stepped to home, T2 contact restores, shorting the totalizer and opening the telephone circuit. Shorting the totalizer releases the B relay. Opening the circuit releases the A relay. Both relays restore to normal.

(d) The CO, detecting the open circuit, applies -130 volts return battery to tip side of line to return the deposit. This causes the coin relay and RE to operate.

(e) As the coin relay releases, HT opens, placing set in its idle or standby condition.

3.15 *Initial Rate Deposited (paragraph 3.05).*

(a) Upon hanging up handset, SH contacts restore and A relay releases. CO removes -48 volts from ring, ground from tip, and a refund (-130 volts) pulse is applied to tip, operating the coin relay and RE, thus releasing T1.

(b) As the coin relay releases, HT opens, placing set in its idle or standby condition.

D. Nickel Local Overtime

3.16 After the called party answers, the CO initiates timing.

3.17 Approximately 30 seconds before the end of the initial period, collect voltage is applied and the initial deposit is collected.

3.18 After approximately a 30 second interval, a coin present test is made.

3.19 If a nickel is deposited, T2 and HT in the coin station operate, the CO reverses battery on the line (applies +48 volts with tip grounded) for approximately 600 milliseconds and the totalizer reads out. When totalizer reads out, T2 reverts to normal.

3.20 With T2 in its normal position, CO applies +48 volts to tip, with ring open, to check for coin presence. If test is satisfied, conversation may continue.

3.21 If a nickel is not deposited, a recording is connected to the line and requests overtime deposit.

- After 30 seconds, an additional coin presence test is made. If a coin is not deposited, the call is terminated.

E. Coin Disposal Test

3.22 Immediately after collect or return voltage is applied following customer disconnect, (on a completed local call) the CO makes a coin disposal test by applying +48 volts to the tip side of the line with ring open.

3.23 If no coin ground is detected, the HT contacts are open and the test is satisfied. If ground is detected, the HT contacts are still closed, indicating a failure to dispose of coin.

3.24 If ground was detected in paragraph 3.23, the CO again applies collect or return voltage and repeats test.

F. Toll Call

3.25 Originate a call as in paragraphs 3.01, 3.02, and 3.03.

3.26 After the number is dialed, the CO automatically applies return voltage and any previous coin deposit is returned, (when coin return option is provided).

3.27 The call is then connected to either a TSPS trunk (ACTS or operator), or to a cord switchboard operator trunk.

3.28 If the call is connected to a TSPS.

- (1) A TSPS operator or ACTS equipment is automatically connected to the calling party.
- (2) The local office TSPS trunk applies +48 volt battery on the ring side of the line toward the station. This replaces the normal -48-volt talk battery on the line which removes the short across the totalizer (positive battery blocked by CR4).

Note: If multiwink signaling (or EIB signaling) is provided, +48-volt battery is provided only when an operator or ACTS equipment is attached.

- (3) The TSPS operator requests the deposit required for initial talk period as displayed on the position, then monitors the coin tones for correct deposit and releases the position from that call.

(4) After the called party answers, the TSPS trunk times the call and at the end of the initial charge period causes the CO to collect the initial deposit and routes the call to an idle TSPS position. (This may not be the same position as before.)

(5) The operator or ACTS equipment is connected to the call and instructs the customer to signal when through. The position is released and the TSPS trunk continues to time the call automatically.

(6) When the customer flashes the switchhook at the end of the call, an idle TSPS position or ACTS equipment is connected. The operator or ACTS equipment requests coin deposit monitors the coin tone signals for correct deposit, collects the deposit, and releases.

(7) The customer hangs up handset. The TSPS sends a coin collect signal to the local office, and a coin disposal test is made, (on ESS and Step-by-Step only). The station is now idle and ready for another call. ***A delay of up to 5 seconds may be required to release the TSPS or CO equipment.***

3.29 If the call is connected to a cord switchboard operator.

- (1) A +48-volt battery is applied to the ring side of the line toward the station.
- (2) The operator requests the deposit required for initial period, monitors the coin tone signals for correct deposit and forwards the call.
- (3) The operator times the call, and at the end of the initial period, collects the deposit, and instructs the customer to signal when through.
- (4) When the customer flashes the switchhook at the end of the call, the operator determines the overtime charge, and requests a coin deposit in the amount of the overtime charge. The operator monitors the coin tone signals for correct deposit, collects the deposit, then disconnects.
- (5) The customer hangs up handset and the station is now idle and ready for another call.

G. Incoming Call

3.30 The CO applies ringing over tip and ring to the station.

Note: Collect to coin service is no longer provided.

3.31 When the handset is lifted, ringing is shorted which trips a relay in the CO thus removing ring battery from the line. The shorting path is from ring, through the A relay winding, normally closed T2, DP contacts (rotary dial only), operated SH2 and SH4 contacts, through the speech network to tip.

3.32 The CO now applies talk battery to ring and ground to tip.

COIN FIRST SERVICE (Fig. 11 and 12)**A. Originating A Call**

3.33 In CF service, the central office is monitoring the ring to ground path (ring -48 volts, tip open).

3.34 When the handset is lifted, switchhook contacts SH3, SH2 and SH4, and SH1 operate in that order and a path exists from ring to the HT contacts. This path is through the normally closed T2 contacts, the DP contacts (rotary dial only), operated SH2 and SH4, through the speech network, transmitter, contacts (TOUCH-TONE dial only), RE, coin relay winding to the normally open HT.

3.35 For a partial deposit of initial rate, T2 operates as well as HT.

3.36 Upon deposit of initial rate, T1 operates, thereby closing the normally open T1 contact, completing the ring to ground path. This path is from ring through the normally closed A relay contact, through operated T1 contacts, F contacts, operated SH3, DP contacts (rotary dial only), operated SH2 and SH4, through the speech network, transmitter, normally closed contacts (TOUCH-TONE dial only), RE, coin relay, HT contacts, to ground.

3.37 The CO applies dial tone and grounds the tip side of the line.

3.38 Grounding the tip operates the A relay causing the A contacts to transfer. Opening the normally closed A contact removes the shorting path from the totalizer. A path now exists through the B relay winding, S (stepping) relay winding, C and S1 totalizer contacts, through operated T1, normally closed F contacts, operated SH3, DP contacts (rotary dial only), operated SH2 and SH4, through the speech network, transmitter, normally closed contacts (TOUCH-TONE dial only), back through the speech network, through the A relay winding to tip. As S1 transfers and the totalizer reads out, the coin tone oscillator is energized intermittently. The operated B relay shorts the speech circuit so the customer cannot hear the generated beep tones.

3.39 When the totalizer steps back to home position, T2 restores, shorting the totalizer and B relay winding. The B relay releases, removing the AC short across the speech network. Even though the totalizer is returned to home position, T1 contact remains operated because it is mechanically latched in its transferred position.

3.40 A dialing and talking path now exists from the ring lead to tip. This path is through the normally closed T2 contacts, normally closed DP contacts (rotary dial only) operated SH2 and SH4, the speech network, transmitter, normally closed contacts (TOUCH-TONE dial only) back through the speech network, through the A relay to tip.

3.41 When dialing with a rotary dial, the dial-off-normal contacts short out the receiver.

3.42 With a TOUCH-TONE dial the common switch contacts operate during dialing to remove the transmitter from the speech network and also removes the shunt.

Note: If the call is a local noncharge call, the deposit will be returned upon completion of call as described in paragraph 3.43.

B. Restoring Set to Standby

3.43 Upon completion of call, customer hangs up handset, SH contacts restore, and the A relay releases. CO removes -48 volts from ring, ground from tip, and a collect (+130 volts) or refund (-130 volts) pulse is applied to tip, operating the coin relay and reset electromagnet (RE).

3.44 Operation of coin relay collects or refunds coin(s), and operation of RE unlatches totalizer contact T1.

3.45 The operated coin relay closes its make contact causing the current to bypass the relay and flow through the resistor which was previously shorted. The short across the relay winding causes the relay to be slow release. The resistor, having approximately the same resistance as the coin relay winding, is placed in the circuit to protect relay contacts in the CO and HT contacts in the set.

3.46 As the coin relay releases, the HT contacts open, placing the coin phone in its idle or standby condition. See coin disposal test, paragraph 3.55.

C. Call Abandoned

3.47 *Partial Initial Rate Deposited, (paragraph 3.35).*

(a) Upon hanging up handset, SH contacts restore and current flows from ring to station ground through the normally closed A contact, normally closed SH3, operated T2, normally closed SH1, the transmitter contacts (TOUCH-TONE dial only) RE, coin relay and HT.

(b) The CO recognizing the ground, applies ground to tip which operates the A relay and removes the short ground around the totalizer.

(c) Current now flows through the polarity guard, B relay winding, S relay winding, C and S1 contacts operated T2, normally closed SH1, the speech network, and the A relay winding to tip.

(d) Operation and release action of the S relay causes the totalizer to operate and step back to home.

(e) When the totalizer has been stepped back to home, T2 contact restores, shorting the totalizer and opening the telephone circuit. Shorting the totalizer releases the B relay. Opening the circuit releases the A relay. Both relays restore to normal.

(f) The CO, detecting the open circuit, applies -130 volts return battery to tip side of line

to return the deposit. This causes the coin relay and RE to operate.

(g) As the coin relay releases, HT opens, placing set in idle or standby condition.

3.48 *Initial Rate Deposited (paragraph 3.36).*

(a) Upon hanging up handset, SH contacts restore and A relay releases. CO removes -48 volts from ring, ground from tip, and a refund (-130 volts) pulse is applied to tip, operating the coin relay and reset electromagnet (RE). T1 contacts of the totalizer are restored.

(b) As the coin relay releases, HT opens, placing set in idle or standby condition.

D. Nickel Local Overtime

3.49 After the called party answers, the CO initiates timing.

3.50 Approximately 30 seconds before the end of the initial period, collect voltage is applied and the initial deposit is collected.

3.51 After approximately a 30 second interval, a coin present test is made.

3.52 If a nickel is deposited, T2 and HT in the coin station operate. When totalizer reads out, T2 reverts to normal.

3.53 With T2 in its normal position, CO applies -48 volts to tip, with ring open, to check for coin presence. If test is satisfied, conversation may continue.

Note: The ESS and combined CF/DTF offices will use +48 volt coin present test. The +48 volt coin present test is then applied. It has no effect in the operation of a coin-first station, but in a combination office (CF/DTF), this feature is necessary to operate a DTF station which has a diode (CR4) around the totalizer.

3.54 If a nickel is not deposited, a recording is connected to the line to request an overtime deposit.

- After 30 seconds, an additional coin presence test is made. If a coin is not deposited, the call is terminated.

E. Coin Disposal-Test

3.55 Immediately after collect or return voltage is applied following customer disconnect, the CO makes a coin disposal test by applying +48 volts to the tip side of the line (ESS), or by applying -48 volt in EM offices on local calls.

3.56 If no coin ground is detected, the HT contacts are open and the test is satisfied. If ground is detected, the HT contacts are still closed, indicating a failure to dispose of coin.

3.57 If ground was detected in paragraph 3.56, the CO again applies collect or return voltage and repeats test.

F. Toll Call

3.58 *Coin-First Station—Coin-First Office.*

- (1) Originate a call as in paragraphs 3.33 through 3.40.
- (2) After the number is dialed, the CO automatically applies return voltage and the deposit is returned (when coin return option is provided).
- (3) The call is then connected to either a TSPS trunk or to a cord switchboard operator trunk.
- (4) ***If the call is connected to a TSPS.***
 - (a) A TSPS operator is automatically connected to the calling party.
 - (b) The TSPS operator requests the deposit required for initial talk period as displayed at the position, then monitors the coin tone signals for correct deposit and releases the position from that call.
 - (c) After the called party answers, the TSPS trunk times the call and at the end of the initial charge period causes the CO to collect the initial deposit and routes the call to an idle TSPS position. (This may not be the same position as before.)

(d) The operator is connected to the call and instructs the customer to signal when through. The position is released and the TSPS trunk continues to time the call automatically.

(e) When the customer flashes the switchhook at the end of the call, an idle TSPS position is connected. The operator requests a deposit in the amount displayed at the position, monitors the coin tone signals for correct deposit, collects the deposit, and releases the position.

(f) The customer hangs up handset. The TSPS sends a coin collect signal to the local office and a coin disposal test (ESS, Step-by-Step offices only) is made. The station is now idle and ready for another call. ***A delay of up to 5 seconds may be required to release the TSPS or CO equipment.***

(5) ***If the call is connected to a cord switchboard operator:***

- (a) The operator requests the deposit required for initial period, monitors the coin tone, signals for correct deposit and forwards the call.
- (b) The operator times the call, and at the end of the initial period collects the deposit, and instructs the customer to signal when through.
- (c) When the customer flashes the switchhook at the end of the call, the operator determines the overtime charge required, and requests a coin deposit in the amount of the overtime charge. The operator monitors the coin tone signals for correct deposit, collects the deposit, then disconnects.
- (d) The customer hangs up handset and the station is restored to the idle state and ready for another call, refer to paragraph 3.29(4).

3.59 *Coin-First Station—Coin-First/Dial-Tone-First Office.*

- (1) Originate a call as in paragraphs 3.33 through 3.40.

(2) After the number is dialed, the CO automatically applies return voltage and any previous deposit is returned, (when coin return option is provided).

(3) The call is then connected to either a TSPS trunk or to a cord switchboard operator trunk.

(4) ***If the call is connected to a TSPS.***

(a) A TSPS operator is automatically connected to the calling party.

(b) The local office TSPS trunk applies +48-volt battery on the ring side of the line toward the station. This replaces the normal -48-volt talk battery on the line.

(c) The TSPS operator requests the deposit required for initial talk period as displayed at the position, then monitors the coin tone signals for correct deposit and releases the position from that call.

(d) After the called party answers, the TSPS trunk times the call and at the end of the initial charge period causes the CO to collect the initial deposit and routes the call to an idle TSPS position. (This may not be the same position as before.)

(e) The operator is connected to the call and instructs the customer to signal when through. The position is released and the TSPS trunk continues to time the call automatically.

(f) When the customer flashes the switchhook at the end of the call, an idle TSPS position is connected. The operator requests coin deposit in amount displayed at the position, monitors the coin tone signals for correct deposit, collects the deposit, and releases the position.

(g) The customer hangs up handset. The TSPS sends a coin collect signal to the local office and a coin disposal test (on ESS and Step-by-Step only) is made. The station is now idle and ready for another call. ***A delay of up to 5 seconds may be required to release the TSPS or CO equipment.***

(5) ***If the call is connected to a cord switchboard operator.***

(a) The +48-volt battery is applied to the ring side of the line toward the station.

(b) The operator requests the deposit required for initial period, monitors the coin tone signals for correct deposit, and forwards the call.

(c) The operator times the call, and at the end of the initial period, collects the deposit, and instructs the customer to signal when through.

(d) When the customer flashes the switchhook at the end of the call, the operator determines the overtime charge, and requests a coin deposit in the amount of overtime charge. The operator monitors the coin tone signals for correct deposit, collects the deposit, then disconnects.

(e) The customer hangs up handset and the station is restored to the idle state and ready for another call.

G. Incoming Call

3.60 The CO applies ringing over tip and ring to the station.

3.61 When the handset is lifted, ringing is shorted which trips a relay in the CO thus removing ring battery from the line. The shorting path is from ring, through the normally closed T2 contacts, DP contacts (rotary dial only), operated SH2 and SH4 contacts, through the speech network, through the A relay winding, to tip.

3.62 The CO now applies talk battery to ring and ground to tip.

4. SEQUENCE CHARTS

4.01 The following is an alphabetical listing of Sequence Charts:

A—Local Call (DTF), Deposit Required

B—Local Call (DTF), No Deposit Required

C—Call Abandoned, Insufficient Deposit Refund (DTF)

D—Call Abandoned, Initial Rate Deposited (DTF)

E—Nickel Local Overtime (CF and DTF)

F—Coin Disposal Test (CF and DTF)

G—Toll Call (DTF)

H—Incoming Call (CF or DTF)

I—Local Charge Call (CF)

J—Local Non-Charge Call (CF)

K—Call Abandoned, Insufficient Deposit Refund (CF)

L—Call Abandoned, Initial Rate Deposited, No Dial Tone (CF)

M—Call Abandoned, Initial Rate Deposited, Dial Tone Received (CF)

N—Toll Call—CF Station, CF Office

O—Toll Call—CF Station, CF/DTF Office

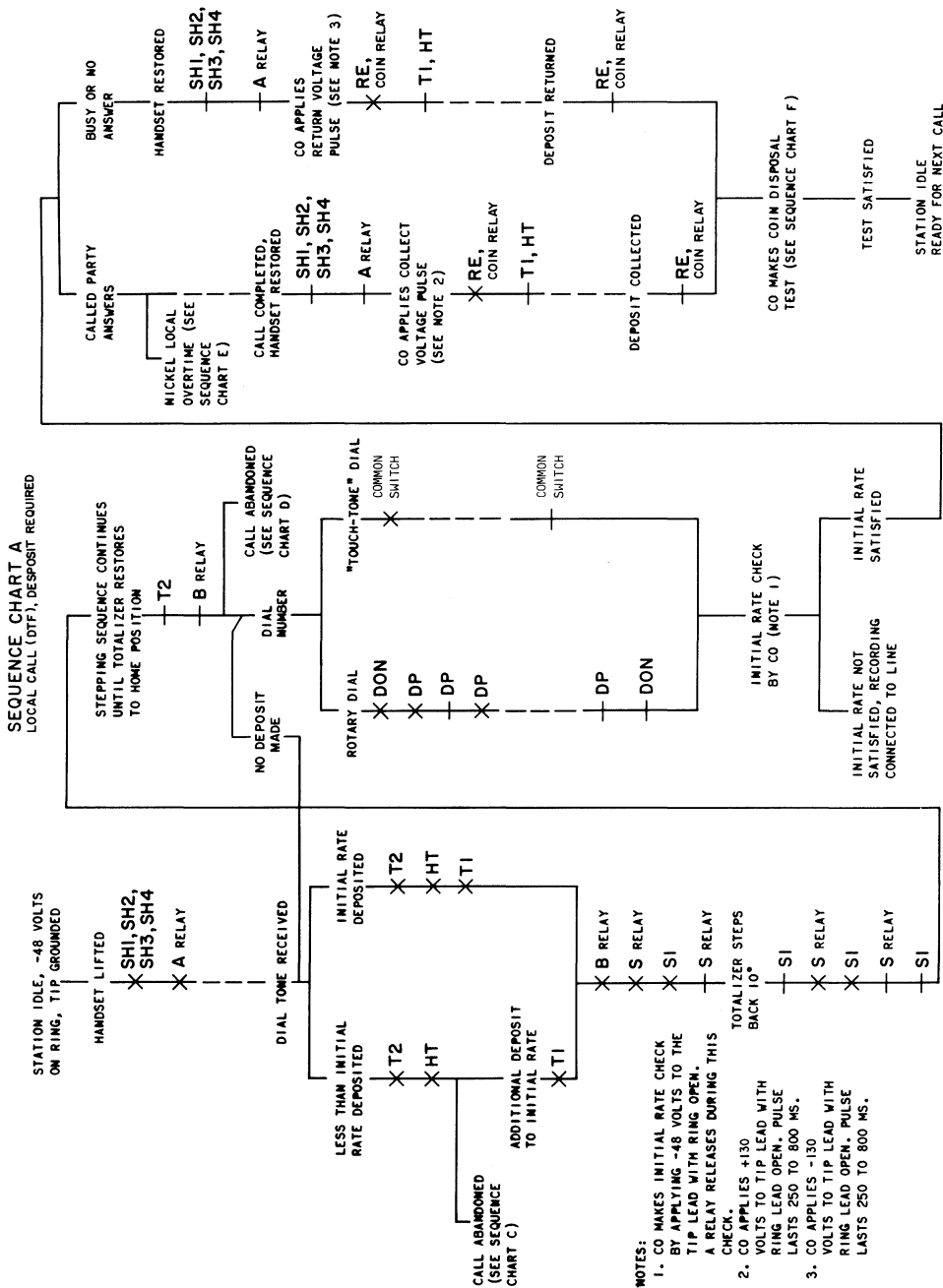

SEQUENCE CHART B
LOCAL CALL (DTF), NO DEPOSIT REQUIRED

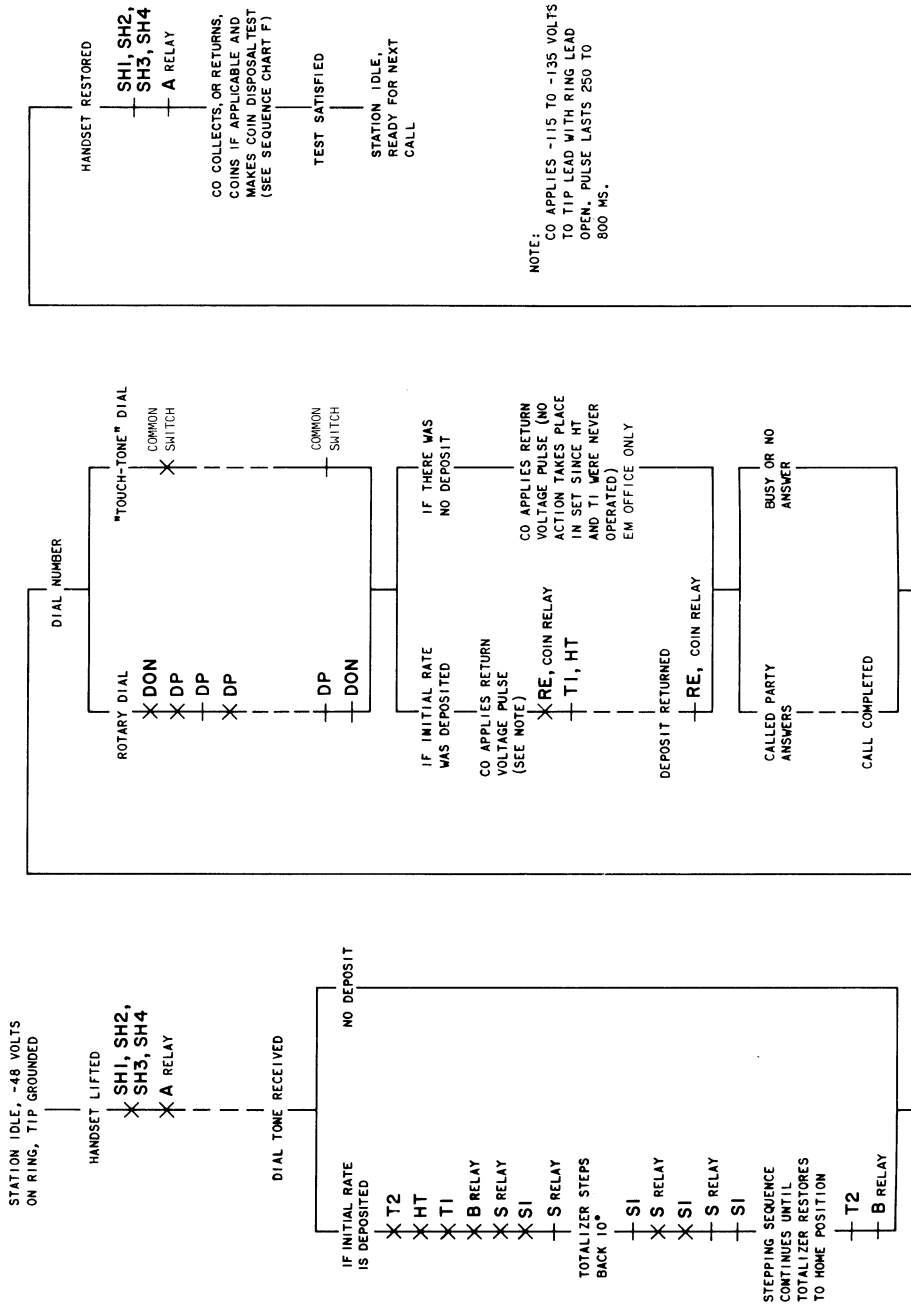

SEQUENCE CHART C
CALL ABANDONED,
INSUFFICIENT DEPOSIT REFUND (DTF)

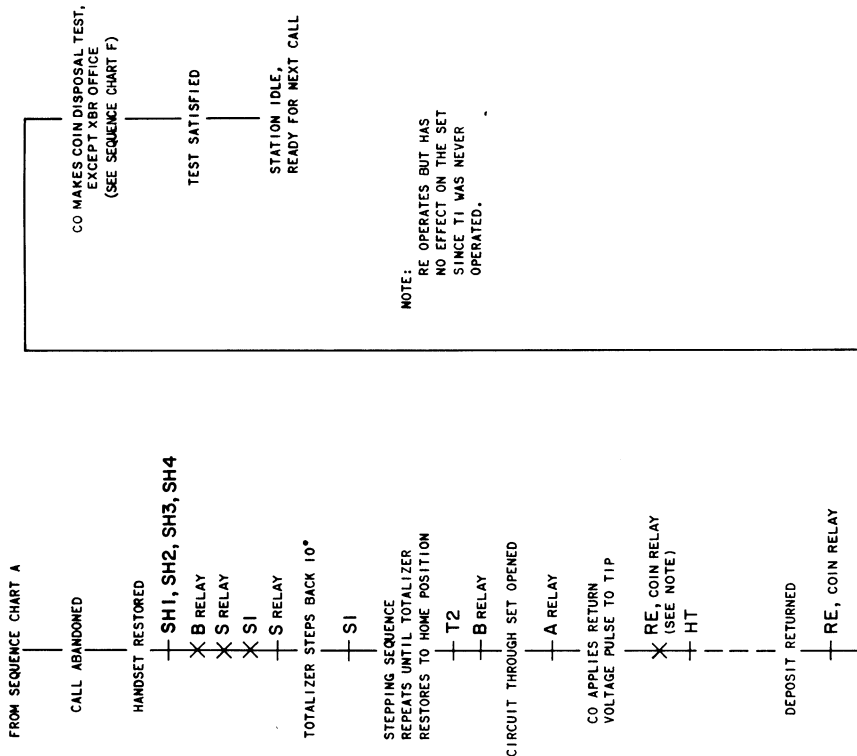

SEQUENCE CHART D
 CALL ABANDONED,
 INITIAL RATE DEPOSITED (DTF)

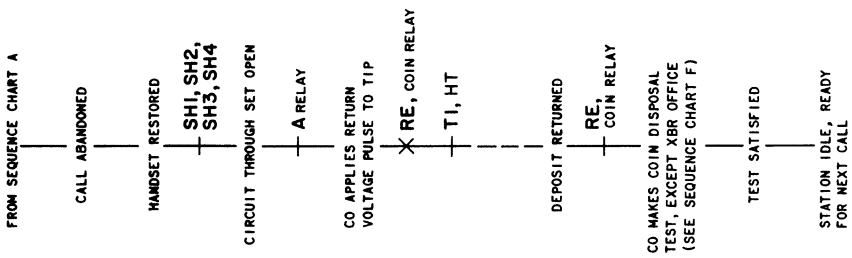

SEQUENCE CHART E
NICKEL LOCAL OVERTIME (CF AND DTF)

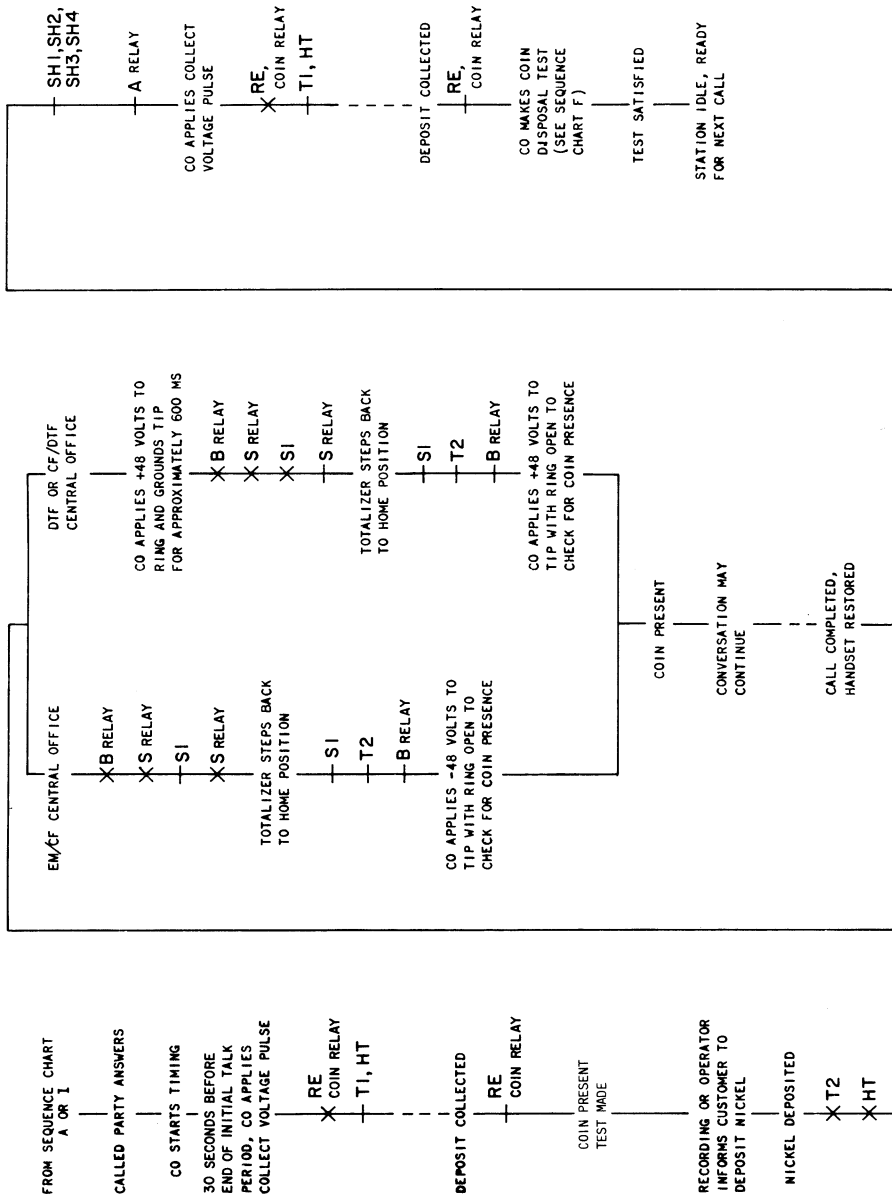

SEQUENCE CHART F
COIN DISPOSAL TEST (CF AND DTF)

FROM SEQUENCE
CHARTS A, B, C, D, E, G,
I, J, K, L, M, N, AND O

CO APPLIES 48 VOLTS TO
TIP WITH RING OPEN
(SEE NOTE)

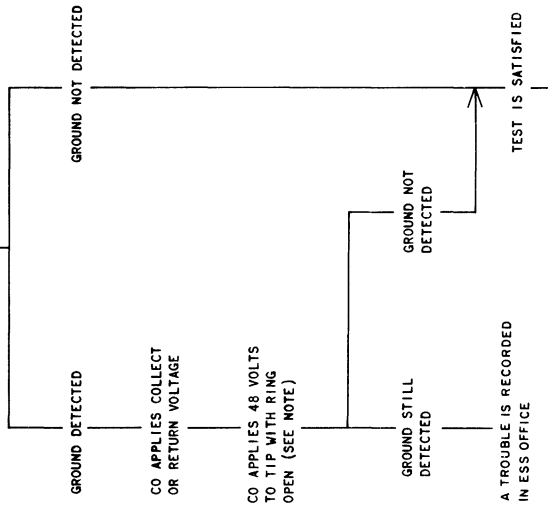

NOTE:
IN A EW/CF OFFICE, -48 VOLTS IS APPLIED; IN A DTF OR
CF/DTF OFFICE, +48 VOLTS IS APPLIED; HOWEVER IN SOME
OFFICES, COIN RETURN VOLTAGE MAY BE USED FOR THIS
TEST.

SEQUENCE CHART G
TOLL CALL-DTF STATION, DTF OFFICE

STATION IDLE, -48 VOLTS
ON RING, TIP GROUNDED

HANDSET LIFTED

SH1, SH2, SH3, SH4
A RELAY

DIAL TONE RECEIVED

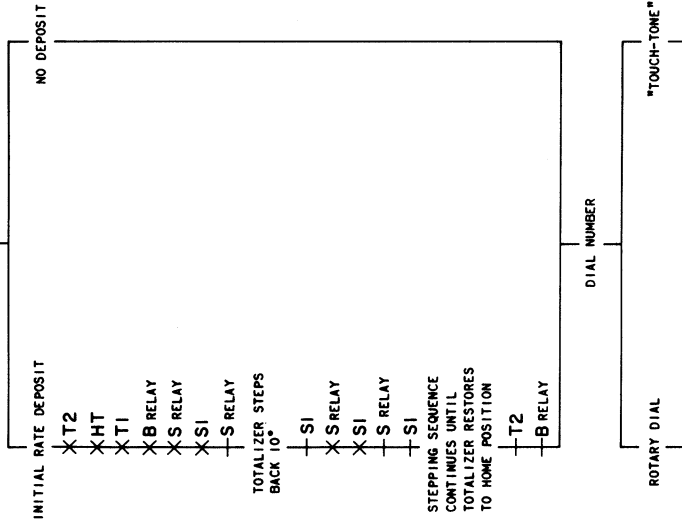

SEQUENCE CHART H
INCOMING CALL (CF OR DTF)

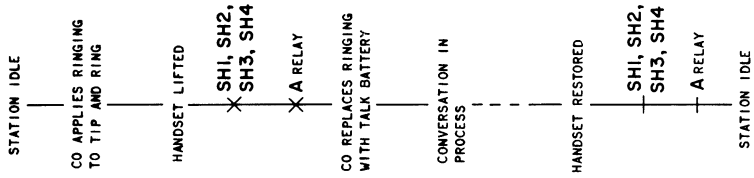

SEQUENCE CHART I
LOCAL CHARGE CALL (CF)

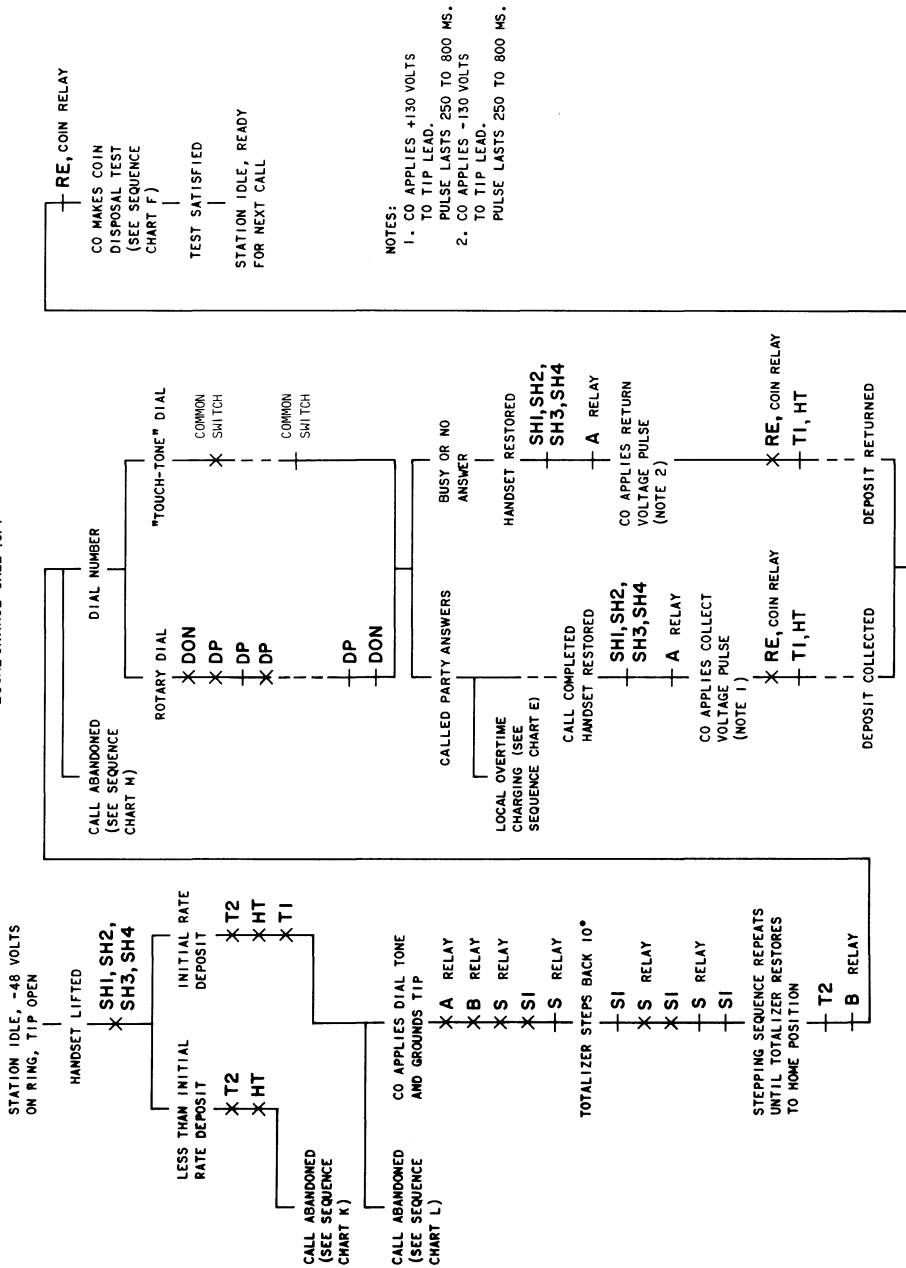

SEQUENCE CHART K
CALL ABANDONED, INSUFFICIENT
DEPOSIT REFUND (CF)

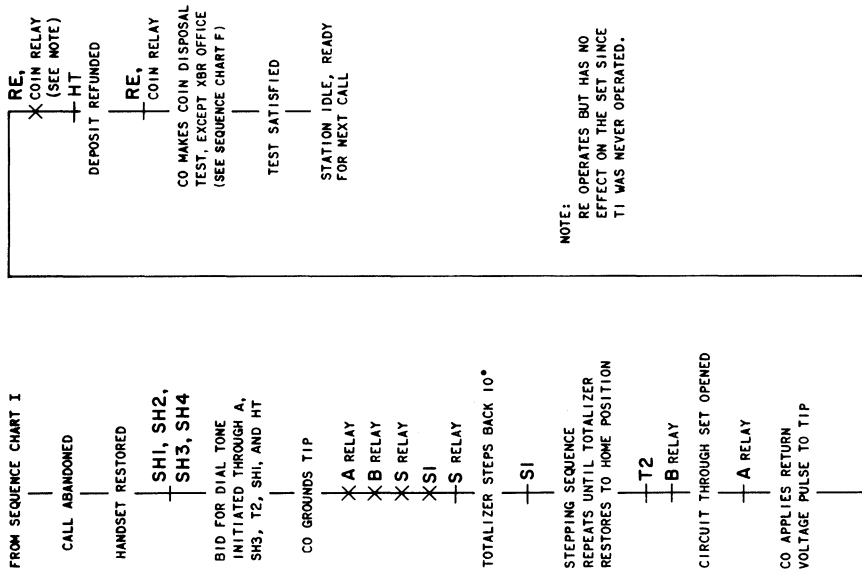

NOTE:
RE OPERATES BUT HAS NO EFFECT ON THE SET SINCE T1 WAS NEVER OPERATED.

SEQUENCE CHART L
 CALL ABANDONED INITIAL RATE
 DEPOSITED, NO DIAL TONE (CF)

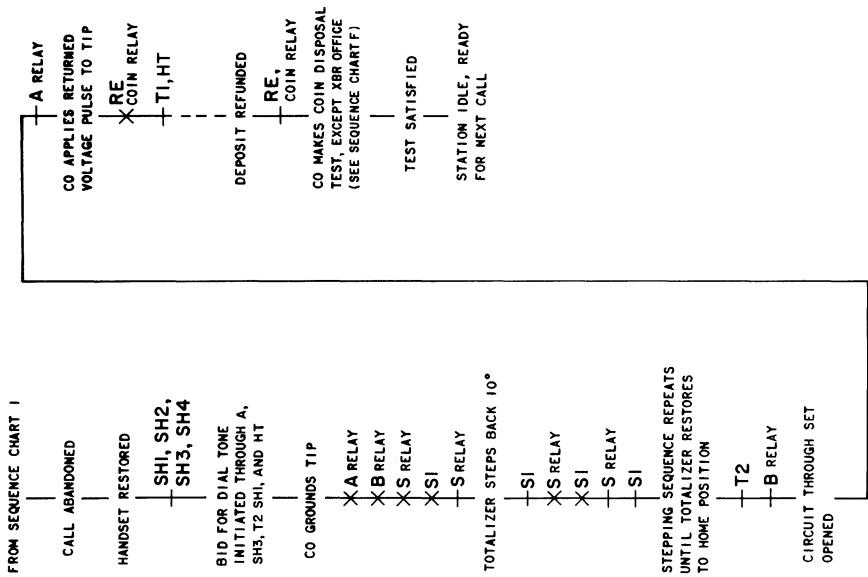

SEQUENCE CHART M
CALL ABANDONED AFTER
INITIAL RATE DEPOSITED AND
DIAL TONE RECEIVED (CF)

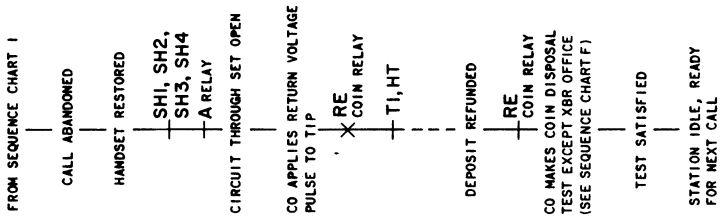

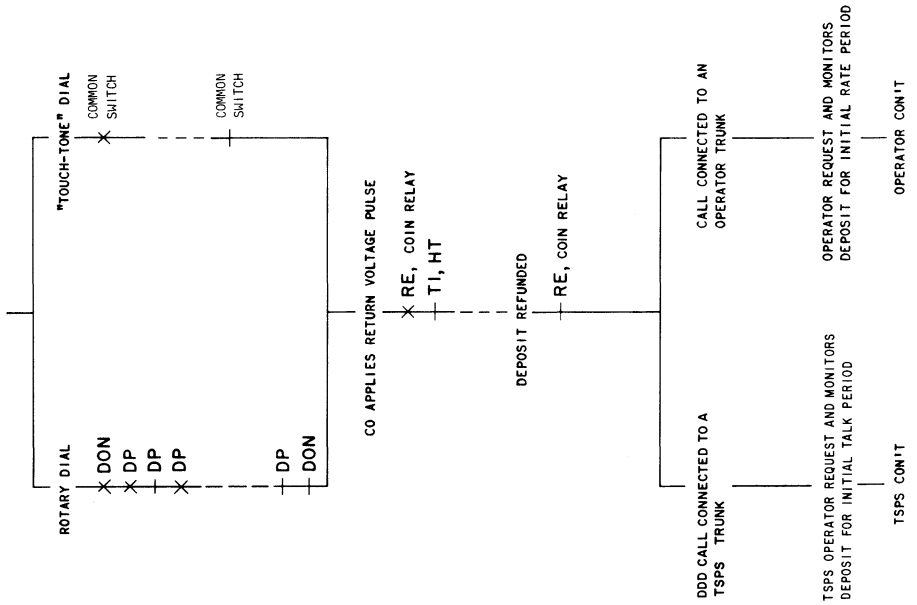
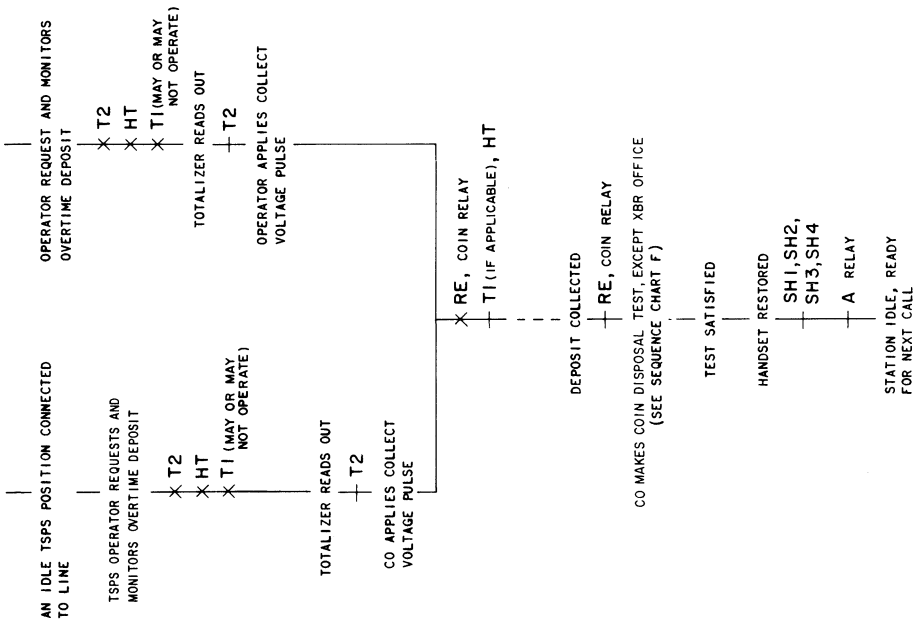

SEQUENCE CHART O
TOLL CALL-CF STATION, CF/DTF OFFICE

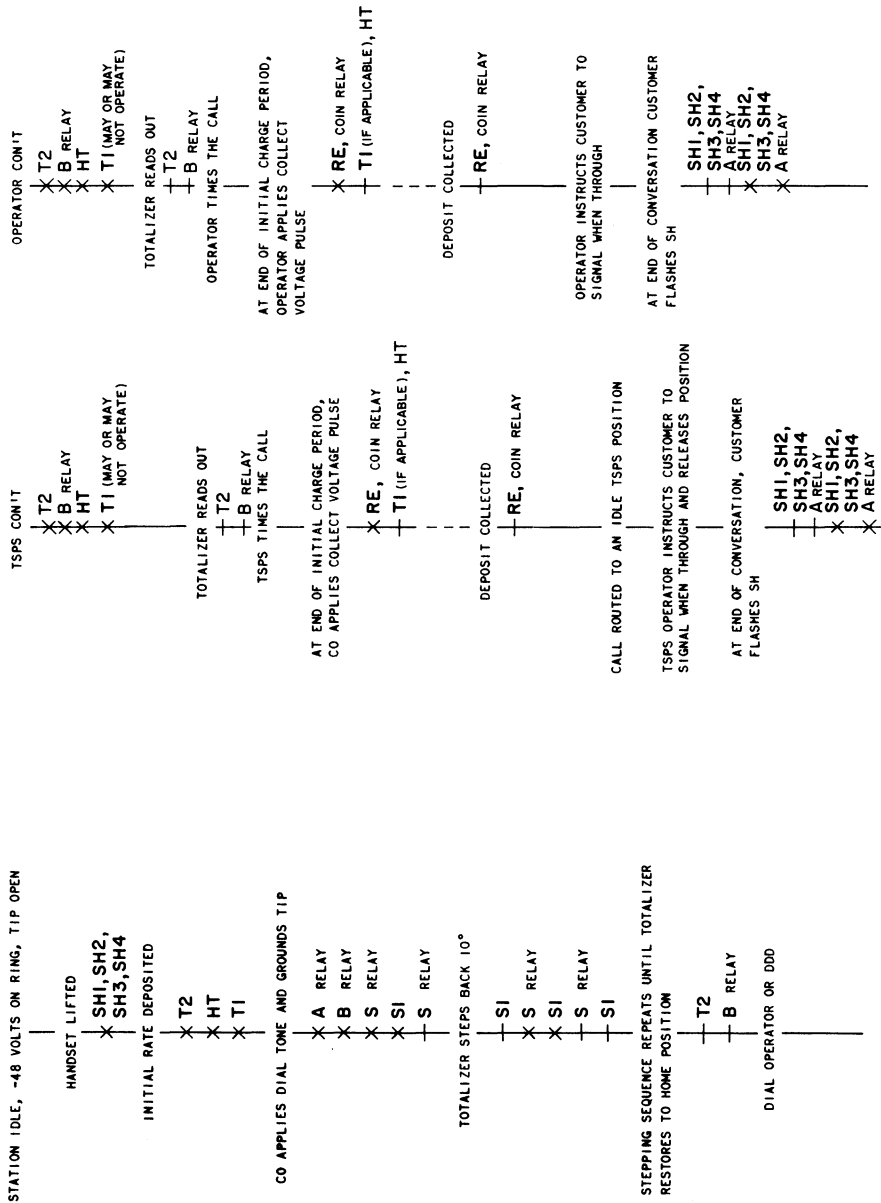

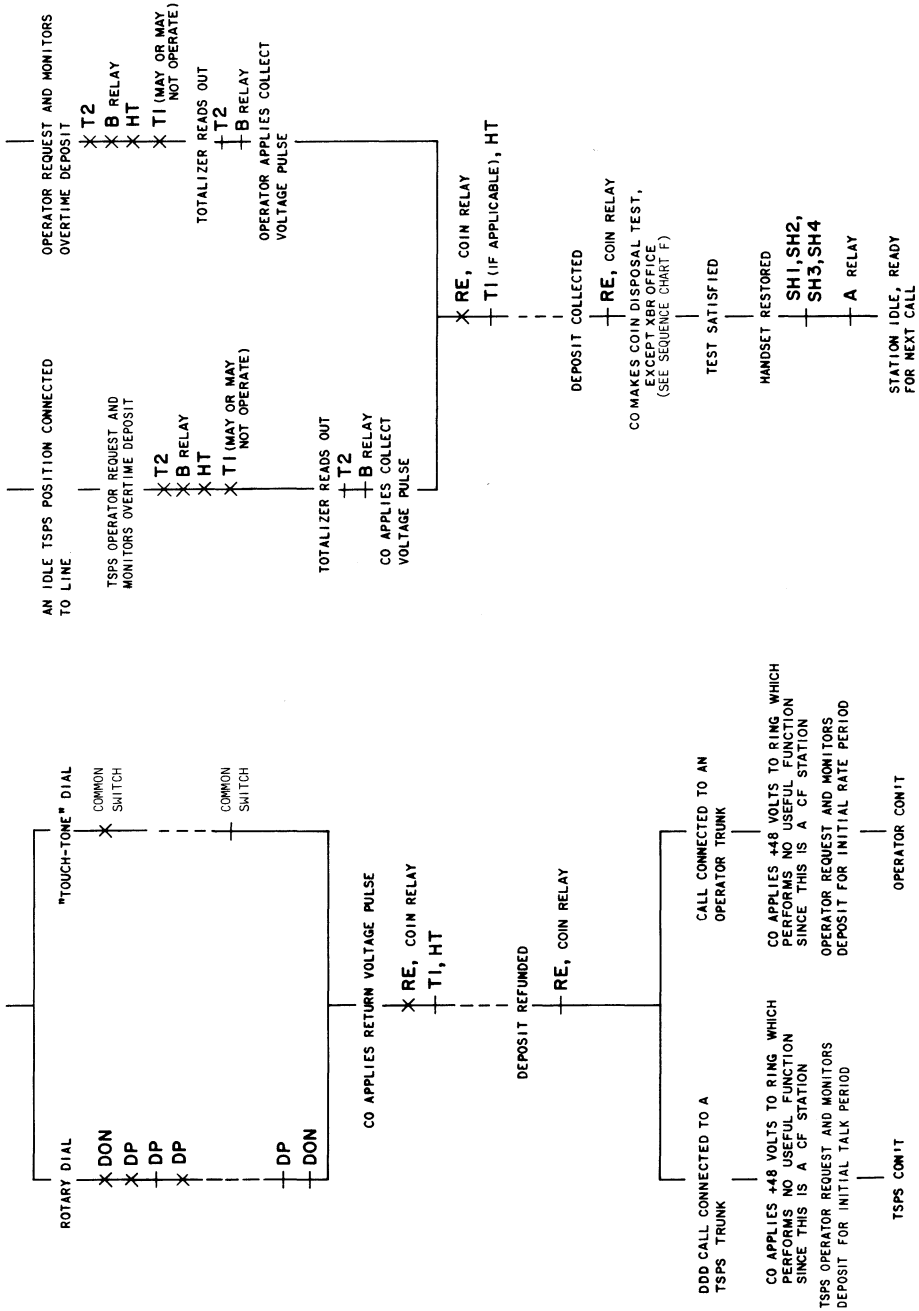

This Page Intentionally Left Blank